

Style

M12 90° Plug
5 pin
D-coding

Ratings

Voltage: 60 V
Current: 4 A

Operating Temperature Range

-40~120°C

Materials

- ① Insulator: Polyamide 66 (PA66), UL94 V-0, black
- ② Pin: C3604 Brass, gold plated
- ③ M12 Shell: Polyamide 66 (PA66), UL94 V-0, black
- ④ Outer Shell: Polyamide 66 (PA66), UL94 V-0, black
- ⑤ Collect nut: Polyamide 66 (PA66), UL94 V-0, black
- ⑥ Collect: Polyamide 66 (PA66), UL94 V-0, black
- ⑦ O-ring: Silicone, green

Electrical Requirements

Dielectric strength: 1 min @ 1500 Vac
Insulation resistance: 100 MΩ @ 500 Vdc
Contact resistance: 0.5 Ω or less

Mechanical Requirements

Life cycle: 500 mating cycles minimum

Assembly Info

Moisture resistant
Waterproof: IP67
Suitable cable OD: 4.0 ~ 6.2 mm
Terminal style: screw
Max torque force:
M12 shell: 0.4 Nm
Collect nut: 0.8 ~ 1.0 Nm

Recommended Wires

AWG	TPU wire	PVC wire	4A compatible
20	30-03085	30-01665	Yes
22	30-03086	30-01666	Yes
24	30-03087	30-01667	Yes
26	30-03088	30-01668	No
28	30-03089	30-01669	No
30	30-03090	30-01670	No
32	30-03091	30-01671	No

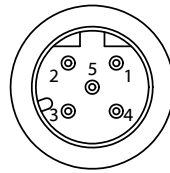

Front View
Not to Scale

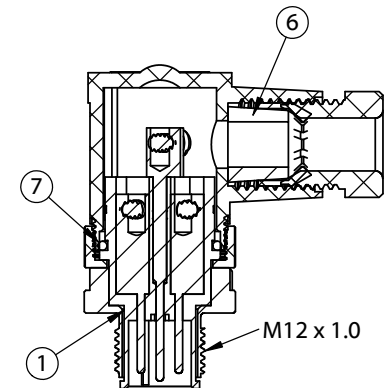
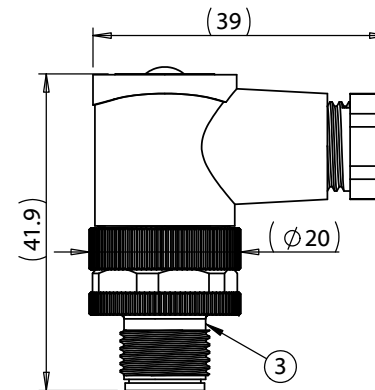
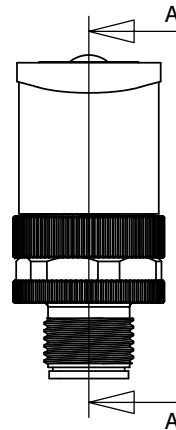
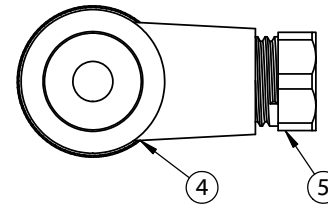
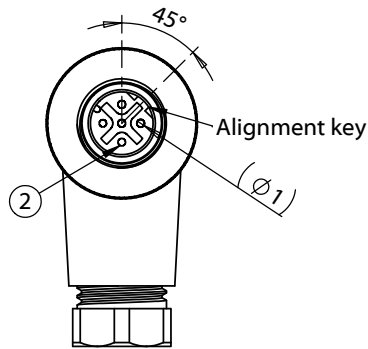

SECTION A-A

Revision:	Date:	Description:	Prepared:	Notes:	<h1>TENSILITY</h1> tel 1.541.323.3228 800 877.670.7118 fax 1.541.323.4202 web tensility.com
A	05/22/2024	Initial release	Verified:	RoHS compliant Function test: no open, no short circuit, no intermittent	
			Dimensions are in millimeters. Tolerances: X: ± 0.3 mm X.X: ± 0.1 mm X.XX: ± 0.05 mm	Description: Connector, M12 D-code plug, 5 pin, 12xL39 mm, 90° gold plated, assembly style, screw terminal, IP67, plastic thread	Size: A Part number: 55-00452
					Scale: 1:1 Sheet 1 of 1