

ITEM NO.	PART NUMBER	DESCRIPTION	QTY.	COMPONENT NOTES
1	50-00993	Connector, 8 pin M12 X-code plug, 12xL38.6mm, gold plated, molding style, solder cup, IP67, shielded	1	
2	50-00995	Connector, 8P8C RJ45 plug, IDC, CAT6a, shielded	1	
3	30-01713	Wire, 4PR BC, 24 AWG, CAT6a SF/UTP, UL20387, 300V, 105C, 60C oil, UV, 7.2 mm, shielded, VW-1, PVC	1	
4	24-00464	Overmold, M12 X-code plug and jack, 90°	1	PVC, black, 60 °C oil and UV resistant
5	24-00362	Overmold, RJ45 plug	1	PVC, black, 60 °C oil and UV resistant
6	Copper tape	Copper foil shielding tape	1	shield between wire and connector

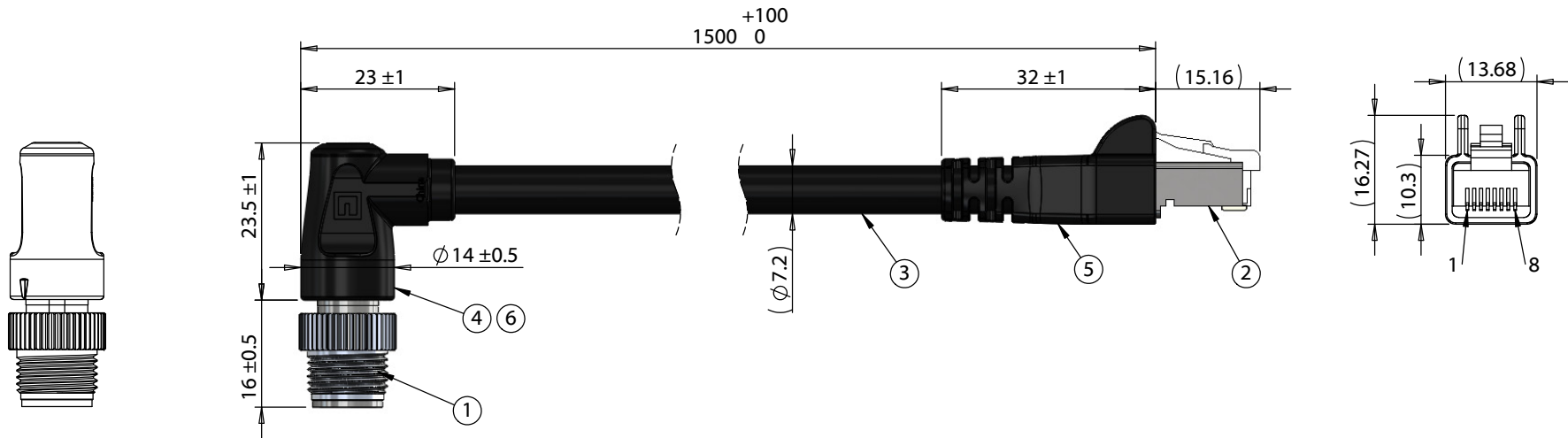

Notes:
 Cable rated for 50 Vac / 60 Vdc, 0.5 A
 Temperature: -25 ~ 105 °C
 Signal: Ethernet CAT6a, 10 Gbps

Wire:
 Oil resistant up to 60 °C
 Water resistant up to 75 °C
 UV resistant

IP67 waterproof rating when M12 connector mated with corresponding (IP67) M12 connector

Functionally equivalent components may be substituted

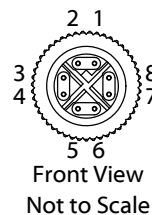
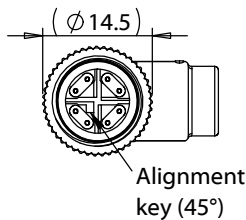

Wiring Diagram		
50-00993	wire color	50-00995
1	orange/white	1
2	orange	2
3	green/white	3
4	green	6
5	brown/white	7
6	brown	8
7	blue/white	5
8	blue	4
Shell	shield	Shell

Revision:	Date:	Description:	Prepared:	Notes: RoHS compliant Function test: no open, no short circuit, no intermittent	<h1>TENSILITY</h1> <p>tel 1.541.323.3228 800 877.670.7118 fax 1.541.323.4202 web tensility.com</p>
A	02/24/2026	Initial release	Verified:		
			Dimensions are in millimeters. Tolerances: X: ± 0.5 mm X.X: ± 0.3 mm X.XX: ± 0.05 mm	Description: Cable, 1500 mm, 8 pin 50-00993 M12 X-code 90° plug to 8P8C 50-00995 RJ45 plug, CAT6a, 24 AWG, 30-01713	Size: A Part number: 10-06560
					Scale: 1:1 Sheet 1 of 1

5

4

3

2

1